

The PE 8300 Series Power Entry Module Filters with Fuses and on/off Switch



PE 8300
Single fuse holder



PE 8400
Double fuse holder



Description :

- The PE 8300/8400 power entry module combines an IEC inlet, a mains filter with single or dualfuse holder and a 2-pole rocker switch in a small form factor.
- High conducted attenuation performance,based on chokes with high saturation resistance and excellent thermal behavior.
- Rated currents up to 10A
- Rear/front or snap-in mounting.
- Single or dual-fuse holder,available for fuses Ø5 x 20mm
- 2-pole rocker switch.
- Optional medical version (B type)
- Snap-in versions (S type)
- Custom-specific versions are available on request.

Typical Applications :

- Single-phase power supplies, switch-mode power supplies
- Test and measurement equipment
- Portable electrical and electronic equipment
- Consumer goods
- EDP and office equipment
- Medical equipment

Electrical Schematic :

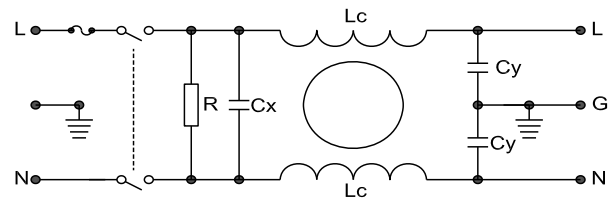

Fig 1

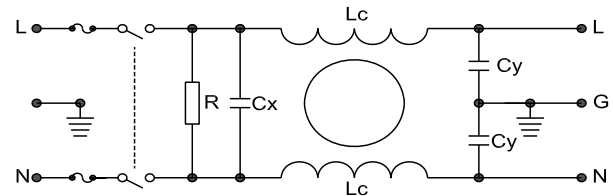

Fig 2

Specification :

Rated Voltage:	120/250 VAC
Rated Current:	1A~10A
Operating Frequency:	50/60Hz
Temperature Range:	HPF 25/085/21
Test Voltage (1min):	
Line to Ground:	2000 VAC
Line to Line:	1450 VDC

Filter Selection Table :

Filter	Rated current (A)	Rated voltage (V)	Leakage Current (mA)	Input/Output connections	Electrical Schematic	Dimension
PE8300-1-01	1	120/250	0.5	01	1	1
PE8300-3-01	3	120/250	0.5	01	1	1
PE8300-6-01	6	120/250	0.5	01	1	1
PE8300-10-01	10	120/250	0.5	01	1	1
PE8400-1-01	1	120/250	0.5	01	2	2
PE8400-3-01	3	120/250	0.5	01	2	2
PE8400-6-01	6	120/250	0.5	01	2	2
PE8400-10-01	10	120/250	0.5	01	2	2

Mechanical Dimension:

(Unit:mm)

All dimensions in mm; 1 inch=25.4mm

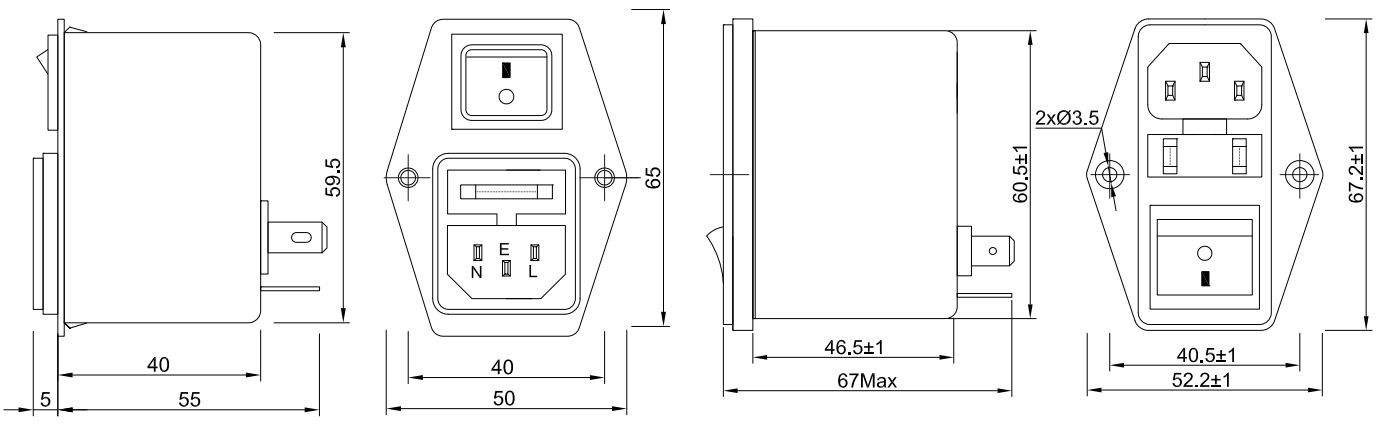
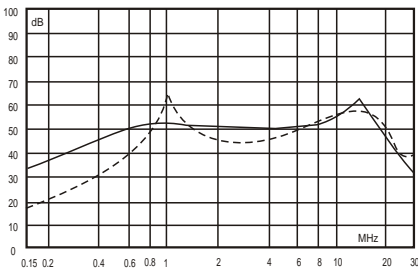

Fig 1

Fig 2

Insertion Loss in dB:

(Measured in 50Ω system , as IEC/CISPR NO.17)



1A

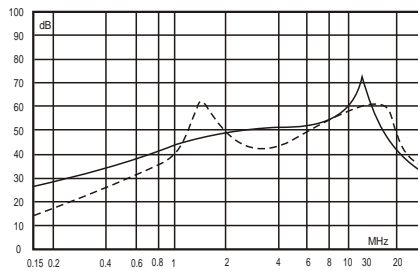

3A

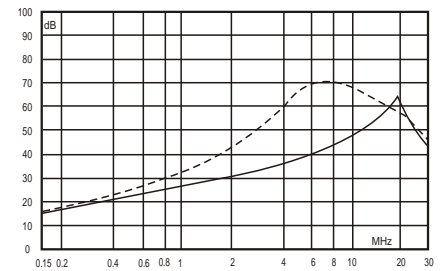

6A

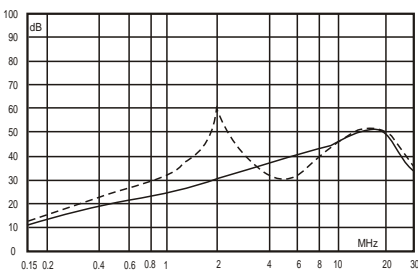

10A

----- Differential Mode
 ——— Common Mode